

ASCO™ MINIATURE SOLENOID VALVES

FLAPPER SOLENOID FLUID ISOLATION VALVES, 22mm

- Flapper isolation valves are designed for use with neutral or highly aggressive liquids in analytical and medical systems
- Special Flapper mechanism results in no pumping or sticking effects
- Reduced heat transfer between control mechanism and fluid make them ideal for use with heat-sensitive reagents and biological samples
- Hermetic separation of control mechanism prevents particulate contamination caused by friction of moving parts, assuring maximum purity of liquid samples
- Excellent self-draining capability and easy-to-flush low-volume internal cavity make these valves ideal in application where cross-contamination must be minimized
- Meets all relevant CE directives, and is RoHS compliant
- Typical applications include:
 - In-vitro Diagnostics
 - Hematology
 - DNA Sequencing
 - Industrial Liquid Analyzers

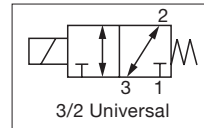
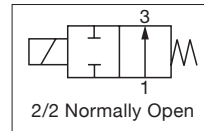
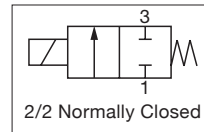

Functional Principle

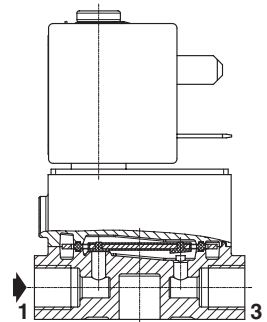

Function 2/2 NC

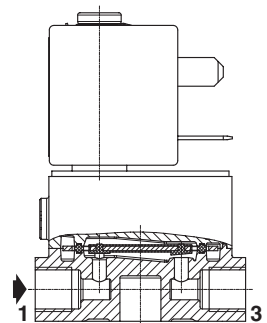

Function 2/2 NO

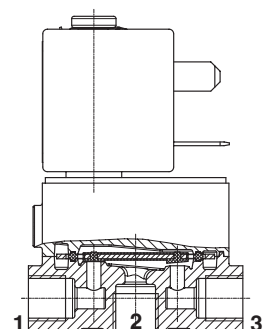

Function 3/2 U

Fluids*	Temperature Range	Seal Materials*
Liquids or Gases ¹	5 °C to 50 °C (41 °F to 122 °F)	FFKM
		FKM
		EPDM

¹ Filtration: 50µm

* Ensure that the compatibility of the materials in contact with the fluids is verified

General Valve Information	
Body	PEEK
Others	Stainless Steel
Response Time	< 10ms
Internal Volume	0.48ml
Max. Viscosity	20 cSt (mm ² /s)

Electrical Characteristics	
Coil Insulation Class	F
Connector	Spade plug (Ø6 to 8mm) or Lead Wires ¹
Connector Specification	DIN 43650, 11mm (0.43in), industry standard B
Electrical Safety	IEC 335 (lead wires: EN 60730)
Electrical Enclosure Protection	Molded IP65 (EN 60529)
Standard Voltages*	12 VDC, 24 VDC (-5%/+10%)

* Other voltages on request

¹ 0.45m (17.7in) lead wires

Prefix Option	Power Ratings			Ambient Temperature Ranges	Replacement Coil		Type ¹
	Inrush	Holding	Hot/Cold		12 VDC	24 VDC	
	VA	VA	W		W	W	
S1	-	-	9.6	5 to 50 (50 to 122)	400129-005	-	01
			10		-	400129-007	
L0	-	-	10	5 to 50 (50 to 122)	400119-011D	400119-008D	02

¹ Refer to the drawings on following pages

01035GB-2019-R01

RECOMMENDATION FOR MAXIMUM DUTY CYCLE

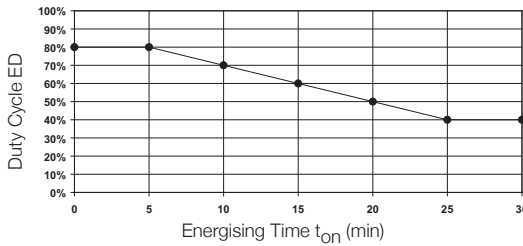

De-energising time: $t_{off} = t_{on} \times (100\% / ED - 1)$

Example:

- 1) Determine energising time in minutes (t_{on}):
 $t_{on} = 15$ min
- 2) Find maximum duty cycle value in diagram:
ED = 60%
- 3) Calculate de-energising time:
 $t_{off} = 15 \text{ min} \times (100\% / 60\% - 1) = 10$ min
- 4) Complete cycle time:
 $t_{cycle} = t_{on} + t_{off} = 15 \text{ min} + 10 \text{ min} = 25$ min

Note: 100% duty cycle possible when using the power-save connector (catalogue number [24 V DC]: 88100934, catalogue number [12 V DC]: 833-150063)

Specifications							
Connection	Orifice Size mm (inches)	Flow Coefficient		Operating Pressure bar (psi)		Power Rating W	Catalog Number Body PEEK
		Kv (m ³ /h)	Cv	min.	max. gases or liquids		
2/2 NC - Normally Closed							
G1/8	2 (0.079)	0.10	0.12	-0.9 (-13)	5 (72.5)	10	G068A317xxx00xx
	3 (0.118)	0.16	0.18	-0.9 (-13)	3 (43)	10	G068A318xxx00xx
	4 (0.157)	0.30	0.35	-0.9 (-13)	1.5 (22)	10	G068A319xxx00xx
Pad Mounting ¹	2 (0.079)	0.10	0.12	-0.9 (-13)	5 (72.5)	10	R068A317xxx00xx
	3 (0.118)	0.16	0.18	-0.9 (-13)	3 (43)	10	R068A318xxx00xx
	4 (0.157)	0.30	0.35	-0.9 (-13)	1.5 (22)	10	R068A319xxx00xx
2/2 NO - Normally Open							
G1/8	2 (0.079)	0.10	0.12	-0.9 (-13)	5 (72.5)	10	G068A327xxx00xx
	3 (0.118)	0.16	0.18	-0.9 (-13)	2 (29)	10	G068A328xxx00xx
	4 (0.157)	0.30	0.35	-0.9 (-13)	1 (14.5)	10	G068A329xxx00xx
Pad Mounting ¹	2 (0.079)	0.10	0.12	-0.9 (-13)	5 (72.5)	10	R068A327xxx00xx
	3 (0.118)	0.16	0.18	-0.9 (-13)	2 (29)	10	R068A328xxx00xx
	4 (0.157)	0.30	0.35	-0.9 (-13)	1 (14.5)	10	R068A329xxx00xx
3/2 U-Universal							
G1/8	2 (0.079)	0.10	0.12	-0.9 (-13)	5 (72.5)	10	G068A337xxx00xx
	3 (0.118)	0.16	0.18	-0.9 (-13)	2 (29)	10	G068A338xxx00xx
	4 (0.157)	0.30	0.35	-0.9 (-13)	1 (14.5)	10	G068A339xxx00xx
Pad Mounting ¹	2 (0.079)	0.10	0.12	-0.9 (-13)	5 (72.5)	10	R068A337xxx00xx
	3 (0.118)	0.16	0.18	-0.9 (-13)	2 (29)	10	R068A338xxx00xx
	4 (0.157)	0.30	0.35	-0.9 (-13)	1 (14.5)	10	R068A339xxx00xx

¹ 4 hexagon socket head cap mounting screws M3 x 8mm (0.31in), stainless steel, ISO 4762 supplied

How to Order

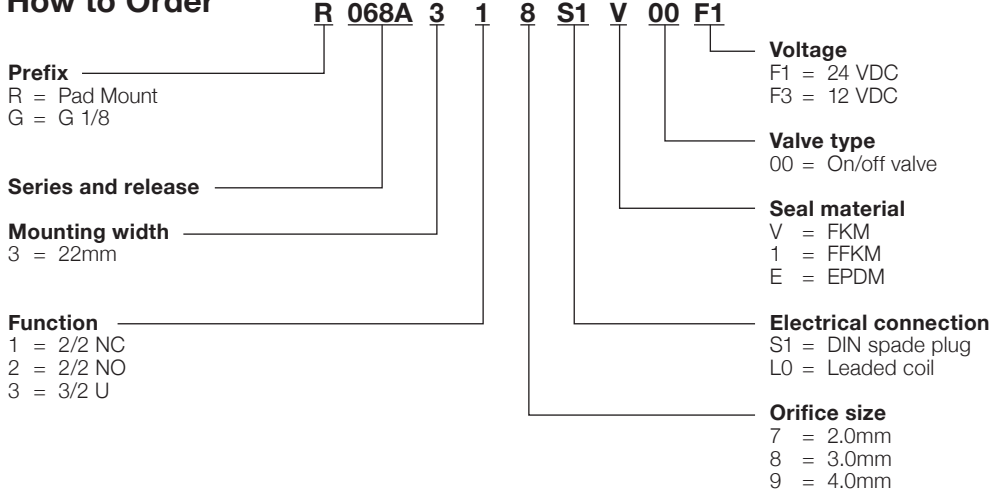

Options

- Subbases available on request
- Power-save connector (2.5 W after 140ms of operation), 24 VDC version: 88100934, 12 VDC version: 833-150063
- Impulse manual operator

Installation

- The solenoid valves can be mounted in any position without affecting operation
- Pad-mounting solenoid valve supplied with seal
- Pipe connections 1/8 have standard thread according to ISO 228/1

ASCO™ MINIATURE SOLENOID VALVES

FLAPPER SOLENOID FLUID ISOLATION VALVES, 22mm

SERIES
068

Dimensions: mm (inches)

Type 01

Solenoid with spade plug connector (S1)
Epoxy molded
IEC 335/DIN 43650
IP65

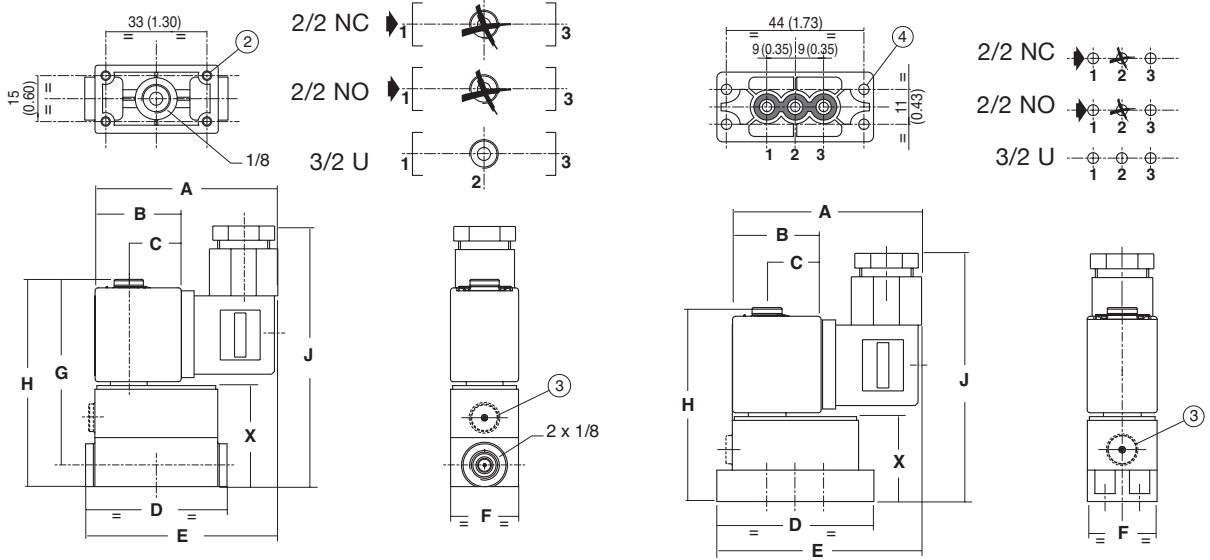

Type 02

Leaded coil (L0)
IEC 335, lead wires:
0.45m (17.7in) long
IP40

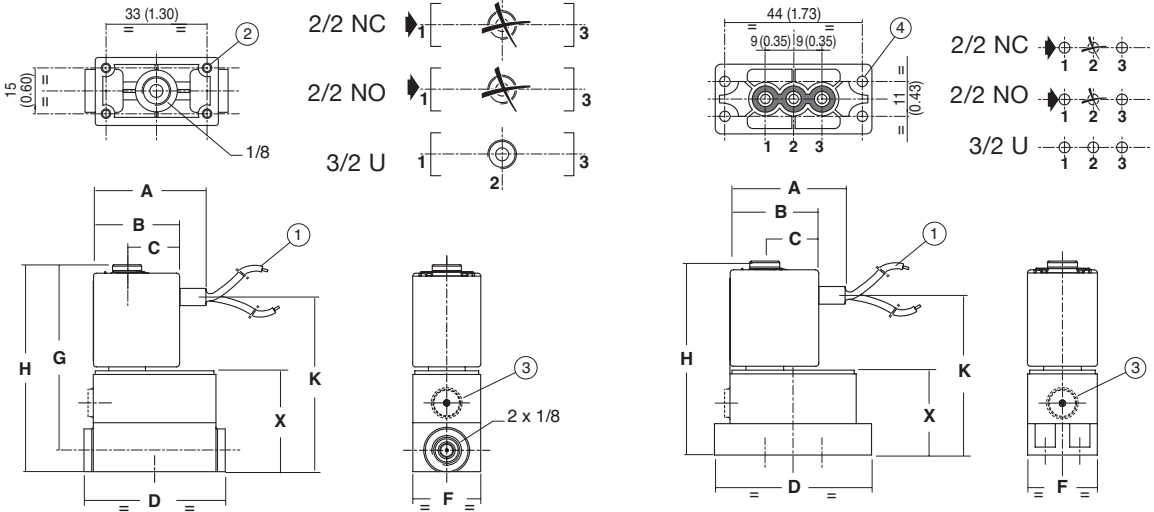

Type	Prefix Option	Catalog Number	A	B	C	D	E	F	G	H	J	K	X	weight kg ¹
01	S1	G068A...S1..	60 (2.36)	28.5 (1.12)	17.5 (0.69)	46.2 (1.82)	62.5 (2.46)	22.3 (0.88)	60.8 (2.40)	67.8 (2.67)	82 (3.23)	-	33 (1.30)	0.130
		R068A...S1..	60 (2.36)	28.5 (1.12)	17.5 (0.69)	50 (1.97)	65 (2.56)	22.3 (0.88)	-	61.8 (2.43)	76 (3.00)	-	27 (1.06)	0.124
02	L0	G068A...L0..	35 (1.38)	28.5 (1.12)	17.5 (0.69)	46.2 (1.82)	-	22.3 (0.88)	60.8 (2.40)	67.8 (2.67)	-	56.5 (2.22)	33 (1.30)	0.124
		R068A...L0..	35 (1.38)	28.5 (1.12)	17.5 (0.69)	50 (1.97)	-	22.3 (0.88)	-	61.8 (2.43)	-	50.5 (1.99)	27 (1.06)	0.120

- ① 2 wires, length 0.45m (17.7in)
- ② 4 mounting holes, max. depth 7mm (0.27in), for self-tapping screw (type EJOT PT, K30)
- ③ Manual operator location
- ④ 4 mounting holes Ø3.2mm (0.126in) (4 hexagon socket head cap mounting screws M3 x 8mm (0.315in), stainless steel, ISO 4762 supplied)

¹ Type 01: includes coil(s) and connector(s); Type 02: with 0.45m (17.7in) lead wires

01035GB-2019-R01

Dimensions: mm (inches)

Subbase Mounting Pattern

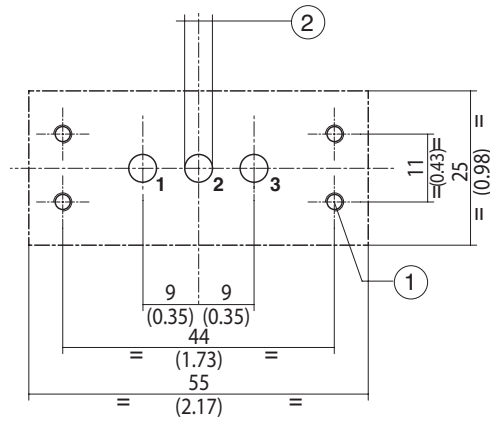
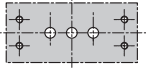

- ① 4 mounting holes Ø3.2mm (0.126in)
- ② Max. diameter 4.5mm (0.177in) 3x

